

382



Valvole a sfera maschio/femmina con premi-stoppa in PTFE

Male/female ball valves with PTFE seal



PASSAGGIO TOTALE
FULL BORE

Per impianti idrotermosanitari, adatte anche al consumo di acqua potabile. Installazione in impianti di media ed alta pressione di distribuzione acqua, riscaldamento industriale, civile, impianti pneumatici, per fluidi non aggressivi.

For plumbing and heating systems, drinking water consumption. Installation in medium and high pressure industrial and civil heating systems, pneumatic systems and for non-aggressive fluids.

PN40



NICHELATE ESTERNAMENTE
EXTERNALLY NICKEL-PLATED



NICHELATE
NICKEL-PLATED

Pressione di esercizio: vedi tabelle

Temperatura di esercizio: -30°C +150°C (gelo escluso)

Filetti cilindrici secondo norma ISO 228-1 (corpo)

Filetto conico secondo norma EN 10226 - ISO7/1 - (manicotto)

Tenuta sull'asta:

- da 1/2" a 2" asta assemblata dall'interno con 1 OR in EPDM PEROX, premistoppa in PTFE, e regolabile con ghiera;

- 1/4" and 3/8" asta assemblata dall'esterno con premistoppa in PTFE e regolabile con ghiera.

Tenuta sulla sfera con 2 sedi in PTFE

Passaggio totale

Working pressure: see tables

Working temperature: -30°C +150°C (no frost)

Cylindrical threads according to ISO 228-1 (body)

Conical threads according to EN 10226 - ISO7/1 (end adaptor)

Seal on the stem:

- from 1/2" to 2" stem assembled from inside with 1 EPDM PEROX OR, PTFE seal and adjustable packing gland;

- 1/4" and 3/8" stem assembled from outside PTFE seal and adjustable packing gland.

Seal on the ball with 2 PTFE gaskets

Full bore

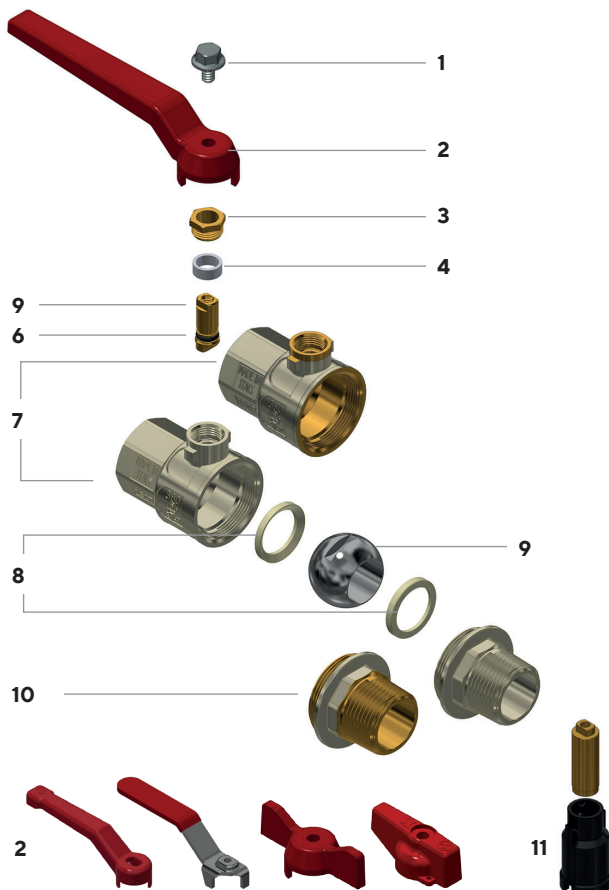

- 1 Vite in acciaio AISI 430
- 2 Leve disponibili: vedi tabelle seguenti
- 3 Ghiera in CW614N UNI EN 12164
- 4 Anello premistoppa in PTFE
- 5 Asta in CW614N UNI EN 12164
- 6 O-ring in EPDM PEROX
- 7 Corpo valvola CW617N UNI EN 12165 nichelato o nichelato solo sulla superficie esterna a seconda del modello (vedi tabelle)
- 8 Sede in PTFE
- 9 Sfera in CW617N UNI EN 12165 cromata
- 10 Manicotto in CW617N UNI EN 12165 nichelato o nichelato solo sulla superficie esterna a seconda del modello (vedi tabelle)
- 11 Per versioni 1/2" e 3/4" canotto prolunga in plastica PA6 caricata 50% fibra di vetro, per versioni da 1" a 2" in CW617N UNI EN 12165 nichelato

- 1 AISI 430 steel screw
- 2 Available levers: see following tables
- 3 CW614N UNI EN 12164 packing gland
- 4 PTFE ring seal
- 5 CW614N UNI EN 12164 stem
- 6 EPDM PEROX O-ring
- 7 CW617N UNI EN 12165 body valve, nickel-plated or nickel-plated on the external surface
- 8 PTFE gasket
- 9 CW617N UNI EN 12165 chrome-plated ball
- 10 CW617N UNI EN 12165 end adaptor, nickel-plated or nickel-plated only on the external surface
- 11 For 1/2" and 3/4" versions extension made of plastic sleeve PA6 loaded 50% glass fibre, for 1" to 2" versions of nickel-plated CW617N UNI EN 12165



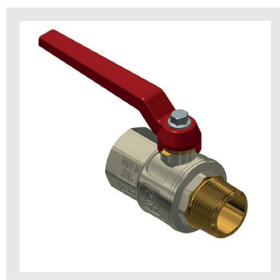

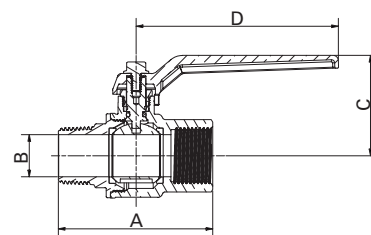

Con leva in alluminio
With aluminium lever

NICHELATE ESTERNAMENTE
EXTERNALLY NICKEL-PLATED





Attacchi Connections	Codice prodotto Product code		PN	A ±1mm	B mm	C mm	D mm	Conf. num. pezzi Pack. num. pieces
								
1/4"	382B1/4G5R	382B1/4G5B	40	53,5	11	41	95	12/144
3/8"	382C3/8G5R	382C3/8G5B	40	53,5	11	41	95	12/144
1/2"	382D1/2G5R	382D1/2G5B	60	63,5	15	43,5	95	10/120
3/4"	382E3/4G5R	382E3/4G5B	60	72,5	20	47	95	6/72
1"	382F001G5R	382F001G5B	40	86	25	62,5	115	4/48
1" 1/4	382G11/4G5R	382G11/4G5B	40	101,5	32	67,5	115	10
1" 1/2	382H11/2G5R	382H11/2G5B	40	109,5	40	80	165	10
2"	382I002G5R	382I002G5B	40	133,5	50	88	165	10

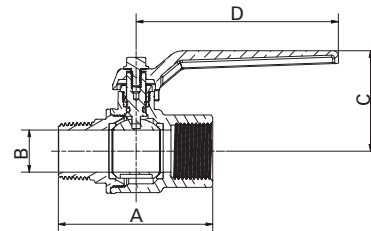

NICHELATE
NICKEL-PLATED



Attacchi Connections	Codice prodotto Product code		PN	A ±1mm	B mm	C mm	D mm	Conf. num. pezzi Pack. num. pieces
								
1/4"	382B1/4C5R	382B1/4C5B	40	53,5	11	41	95	12/144
3/8"	382C3/8C5R	382C3/8C5B	40	53,5	11	41	95	12/144
1/2"	382D1/2C5R	382D1/2C5B	60	63,5	15	43,5	95	10/120
3/4"	382E3/4C5R	382E3/4C5B	60	72,5	20	47	95	6/72
1"	382F001C5R	382F001C5B	40	86	25	62,5	115	4/48
1" 1/4	382G11/4C5R	382G11/4C5B	40	101,5	32	67,5	115	10
1" 1/2	382H11/2C5R	382H11/2C5B	40	109,5	40	80	165	10
2"	382I002C5R	382I002C5B	40	133,5	50	88	165	10

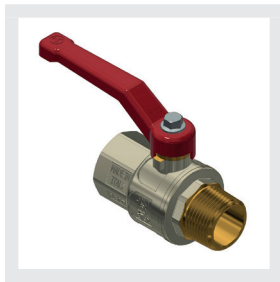



Con leva in acciaio imbutita
With drawn steel lever

NICHELATE ESTERNAMENTE
EXTERNALLY NICKEL-PLATED

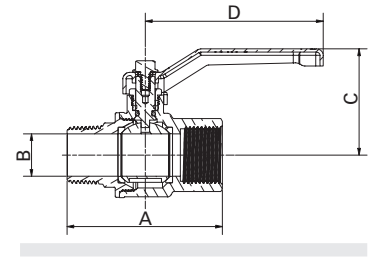
 **ACQUA POTABILE**
DRINKING WATER





Attacchi Connections	Codice prodotto Product code		PN	A ±1mm	B mm	C mm	D mm	Conf. num. pezzi Pack. num. pieces
								
1/4"	382B1/4G1R	382B1/4G1B	40	53,5	11	44	83	12/144
3/8"	382C3/8G1R	382C3/8G1B	40	53,5	11	44	83	12/144
1/2"	382D1/2G1R	382D1/2G1B	60	63,5	15	46	83	10/120
3/4"	382E3/4G1R	382E3/4G1B	60	72,5	20	49,5	83	6/72
1"	382F001G1R	382F001G1B	40	86	25	68	90	4/48
1" 1/4	382G11/4G1R	382G11/4G1B	40	101,5	32	73	90	10
1" 1/2	382H11/2G1R	382H11/2G1B	40	109,5	40	82	160	10
2"	382I002G1R	382I002G1B	40	133,5	50	90	160	10

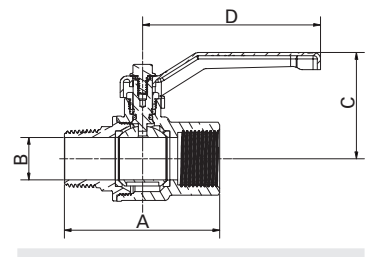

NICHELATE
NICKEL-PLATED



Attacchi Connections	Codice prodotto Product code		PN	A ±1mm	B mm	C mm	D mm	Conf. num. pezzi Pack. num. pieces
								
1/4"	382B1/4C1R	382B1/4C1B	40	53,5	11	44	83	12/144
3/8"	382C3/8C1R	382C3/8C1B	40	53,5	11	44	83	12/144
1/2"	382D1/2C1R	382D1/2C1B	60	63,5	15	45	83	10/120
3/4"	382E3/4C1R	382E3/4C1B	60	72,5	20	48	83	6/72
1"	382F001C1R	382F001C1B	40	86	25	68	90	4/48
1" 1/4	382G11/4C1R	382G11/4C1B	40	101,5	32	73	90	10
1" 1/2	382H11/2C1R	382H11/2C1B	40	109,5	40	82	160	10
2"	382I002C1R	382I002C1B	40	133,5	50	90	160	10



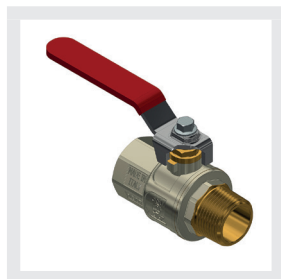

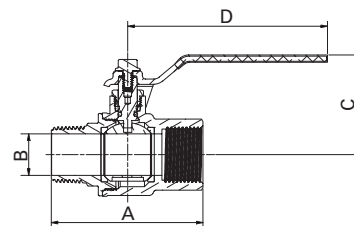

Con leva piatta in acciaio INOX AISI 304
With AISI 304 stainless steel flat lever

NICHELATE ESTERNAMENTE
EXTERNALLY NICKEL-PLATED





Attacchi Connections	Codice prodotto Product code		PN	A ±1mm	B mm	C mm	D mm	Conf. num. pezzi Pack. num. pieces
								
1/4"	382B1/4G4R	382B1/4G4B	40	53,5	11	41	95	12/144
3/8"	382C3/8G4R	382C3/8G4B	40	53,5	11	41	95	12/144
1/2"	382D1/2G4R	382D1/2G4B	60	63,5	15	43,5	95	10/120
3/4"	382E3/4G4R	382E3/4G4B	60	72,5	20	47	95	6/72
1"	382F001G4R	382F001G4B	40	86	25	60,5	115	4/48
1" 1/4	382G11/4G4R	382G11/4G4B	40	101,5	32	65,5	115	10
1" 1/2	382H11/2G4R	382H11/2G4B	40	109,5	40	77,5	165	10
2"	382I002G4R	382I002G4B	40	133,5	50	85,5	165	10

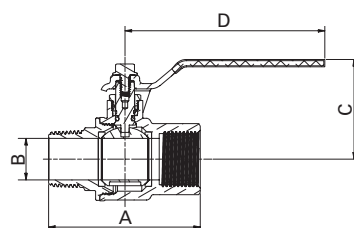

NICHELATE
NICKEL-PLATED



Attacchi Connections	Codice prodotto Product code		PN	A ±1mm	B mm	C mm	D mm	Conf. num. pezzi Pack. num. pieces
								
1/4"	382B1/4C4R	382B1/4C4B	40	53,5	11	41	95	12/144
3/8"	382C3/8C4R	382C3/8C4B	40	53,5	11	41	95	12/144
1/2"	382D1/2C4R	382D1/2C4B	60	63,5	15	43,5	95	10/120
3/4"	382E3/4C4R	382E3/4C4B	60	72,5	20	47	95	6/72
1"	382F001C4R	382F001C4B	40	86	25	60,5	115	4/48
1" 1/4	382G11/4C4R	382G11/4C4B	40	101,5	32	65,5	115	10
1" 1/2	382H11/2C4R	382H11/2C4B	40	109,5	40	77,5	165	10
2"	382I002C4R	382I002C4B	40	133,5	50	85,5	165	10

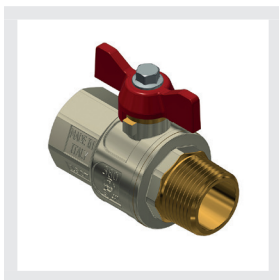



Con farfalla in alluminio "T"
With aluminium "T" handle

NICHELATE ESTERNAMENTE
EXTERNALLY NICKEL-PLATED

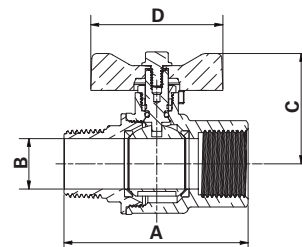
 **ACQUA POTABILE**
DRINKING WATER



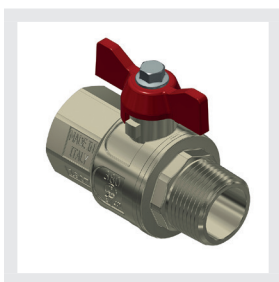

Attacchi Connections	Codice prodotto Product code		PN	A ±1mm	B mm	C mm	D mm	Conf. num. pezzi Pack. num. pieces
								
1/4"	382B1/4G6R	382B1/4G6B	40	53,5	11	37,5	52	12/144
3/8"	382C3/8G6R	382C3/8G6B	40	53,5	11	37,5	52	12/144
1/2"	382D1/2G6R	382D1/2G6B	60	63,5	15	39,5	52	10/120
3/4"	382E3/4G6R	382E3/4G6B	60	72,5	20	43,5	52	8/96
1"	382F001G6R	382F001G6B	40	86	25	51,5	65	4/48

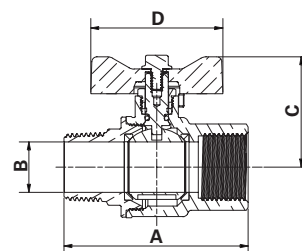

NICHELATE
NICKEL-PLATED



Attacchi Connections	Codice prodotto Product code		PN	A ±1mm	B mm	C mm	D mm	Conf. num. pezzi Pack. num. pieces
								
1/4"	382B1/4C6R	382B1/4C6B	40	53,5	11	37,5	52	12/144
3/8"	382C3/8C6R	382C3/8C6B	40	53,5	11	37,5	52	12/144
1/2"	382D1/2C6R	382D1/2C6B	60	63,5	15	39,5	52	10/120
3/4"	382E3/4C6R	382E3/4C6B	60	72,5	20	43,5	52	8/96
1"	382F001C6R	382F001C6B	40	86	25	51,5	65	4/48



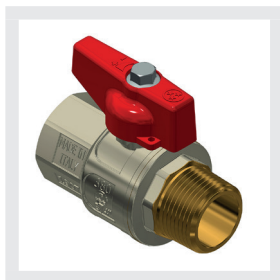

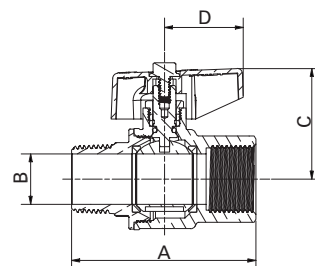

Con manopola in alluminio
With aluminium knob

NICHELATE ESTERNAMENTE
EXTERNALLY NICKEL-PLATED



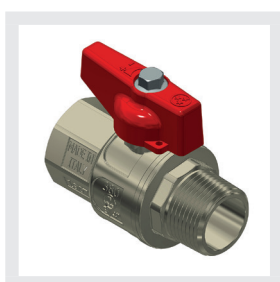

Attacchi Connections	Codice prodotto Product code		PN	A ±1mm	B mm	C mm	D mm	Conf. num. pezzi Pack. num. pieces
								
1/4"	382B1/4G2R	382B1/4G2B	40	53,5	11	34	31,5	12/144
3/8"	382C3/8G2R	382C3/8G2B	40	53,5	11	34	31,5	12/144
1/2"	382D1/2G2R	382D1/2G2B	60	63,5	15	40	31,5	10/120
3/4"	382E3/4G2R	382E3/4G2B	60	72,5	20	43,5	31,5	6/72
1"	382F001G2R	382F001G2B	40	86	25	54	42,5	4/48
1" 1/4"	382G11/4G2R	382G11/4G2B	40	101,5	32	68	50	10

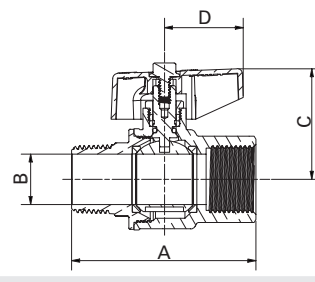

NICHELATE
NICKEL-PLATED



Attacchi Connections	Codice prodotto Product code		PN	A ±1mm	B mm	C mm	D mm	Conf. num. pezzi Pack. num. pieces
								
1/4"	382B1/4C2R	382B1/4C2B	40	53,5	11	34	31,5	12/144
3/8"	382C3/8C2R	382C3/8C2B	40	53,5	11	34	31,5	12/144
1/2"	382D1/2C2R	382D1/2C2B	60	63,5	15	40	31,5	10/120
3/4"	382E3/4C2R	382E3/4C2B	60	72,5	20	43,5	31,5	6/72
1"	382F001C2R	382F001C2B	40	86	25	54	42,5	4/48
1" 1/4"	382G11/4C2R	382G11/4C2B	40	101,5	32	68	50	10





Con prolunga e leva in alluminio With extension stem and aluminium lever

NICHELATE ESTERNAMENTE EXTERNALLY NICKEL-PLATED

Per versioni 1/2" e 3/4" canotto prolunga in plastica PA6 caricata 50% fibra di vetro, per versioni da 1" a 2" in CW617N UNI EN 12165 nichelato

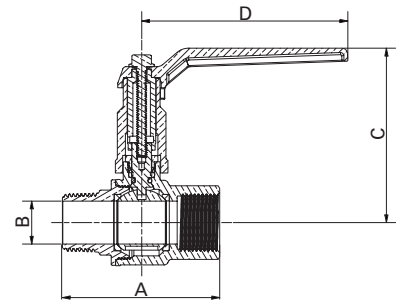
For 1/2" and 3/4" versions extension made of plastic sleeve PA6 loaded 50% glass fibre, for 1" to 2" versions of nickel-plated CW617N UNI EN 12165



Attacchi Connections	Codice prodotto Product code		PN	A ±1mm	B mm	C mm	D mm	Conf. num. pezzi Pack. num. pieces
								
1/2"	382D1/2G5RFM	382D1/2G5BFM	60	63,5	15	77	95	10/120
3/4"	382E3/4G5RF	382E3/4G5BF	60	72,5	20	80,5	95	6/72
1"	382F001G5RF	382F001G5BF	40	86	25	99,5	115	4/48
1" 1/4	382G11/4G5RF	382G11/4G5BF	40	101,5	32	104,5	115	10
1" 1/2	382H11/2G5RF	382H11/2G5BF	40	109,5	40	132	165	10
2"	382I002G5RF	382I002G5BF	40	133,5	50	140	165	10





NICHELATE NICKEL-PLATED

Per versioni 1/2" e 3/4" canotto prolunga in plastica PA6 caricata 50% fibra di vetro, per versioni da 1" a 2" in CW617N UNI EN 12165 nichelato

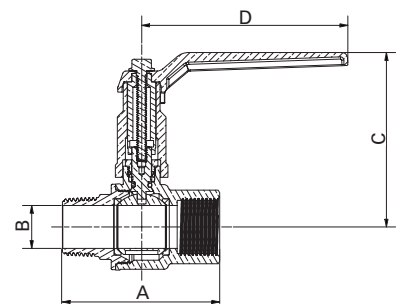
For 1/2" and 3/4" versions extension made of plastic sleeve PA6 loaded 50% glass fibre, for 1" to 2" versions of nickel-plated CW617N UNI EN 12165



Attacchi Connections	Codice prodotto Product code		PN	A ±1mm	B mm	C mm	D mm	Conf. num. pezzi Pack. num. pieces
								
1/2"	382D1/2C5RFM	382D1/2C5BFM	60	63,5	15	77	95	10/120
3/4"	382E3/4C5RF	382E3/4C5BF	60	72,5	20	80,5	95	6/72
1"	382F001C5RF	382F001C5BF	40	86	25	99,5	115	4/48
1" 1/4	382G11/4C5RF	382G11/4C5BF	40	101,5	32	104,5	115	10
1" 1/2	382H11/2C5RF	382H11/2C5BF	40	109,5	40	132	165	10
2"	382I002C5RF	382I002C5BF	40	133,5	50	140	165	10





Con prolunga e leva in acciaio imbutita
With extension stem and drawn steel lever

NICHELATE ESTERNAMENTE
EXTERNALLY NICKEL-PLATED

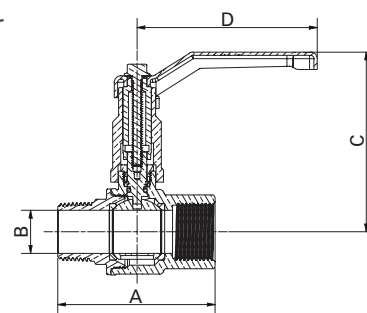
Per versioni 1/2" e 3/4" canotto prolunga in plastica PA6 caricata 50% fibra di vetro, per versioni da 1" a 2" in CW617N UNI EN 12165 nichelato
 For 1/2" and 3/4" versions extension made of plastic sleeve PA6 loaded 50% glass fibre, for 1" to 2" versions of nickel-plated CW617N UNI EN 12165





Attacchi Connections	Codice prodotto Product code		PN	A ±1mm	B mm	C mm	D mm	Conf. num. pezzi Pack. num. pieces
								
1/2"	382D1/2G1RFM	382D1/2G1BFM	60	63,5	15	79,5	83	30
3/4"	382E3/4G1RF	382E3/4G1BF	60	72,5	20	83	83	25
1"	382F001G1RF	382F001G1BF	40	86	25	105	90	25
1" 1/4	382G11/4G1RF	382G11/4G1BF	40	101,5	32	110	90	20
1" 1/2	382H11/2G1RF	382H11/2G1BF	40	109,5	40	134	160	10
2"	382I002G1RF	382I002G1BF	40	133,5	50	142	160	10

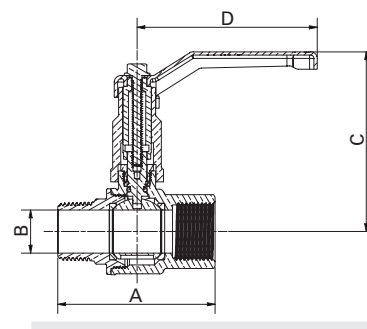

NICHELATE
NICKEL-PLATED

Per versioni 1/2" e 3/4" canotto prolunga in plastica PA6 caricata 50% fibra di vetro, per versioni da 1" a 2" in CW617N UNI EN 12165 nichelato
 For 1/2" and 3/4" versions extension made of plastic sleeve PA6 loaded 50% glass fibre, for 1" to 2" versions of nickel-plated CW617N UNI EN 12165



Attacchi Connections	Codice prodotto Product code		PN	A ±1mm	B mm	C mm	D mm	Conf. num. pezzi Pack. num. pieces
								
1/2"	382D1/2C1RFM	382D1/2C1BFM	60	63,5	15	79,5	83	30
3/4"	382E3/4C1RF	382E3/4C1BF	60	72,5	20	83	83	25
1"	382F001C1RF	382F001C1BF	40	86	25	105	90	25
1" 1/4	382G11/4C1RF	382G11/4C1BF	40	101,5	32	110	90	20
1" 1/2	382H11/2C1RF	382H11/2C1BF	40	109,5	40	134	160	10
2"	382I002C1RF	382I002C1BF	40	133,5	50	142	160	10





Con prolunga e farfalla in alluminio "T" With extension stem and aluminium "T" handle

NICHELATE ESTERNAMENTE EXTERNALLY NICKEL-PLATED

Per versioni 1/2" e 3/4" canotto prolunga in plastica PA6 caricata 50% fibra di vetro, per versioni da 1" a 1" in CW617N UNI EN 12165 nichelato

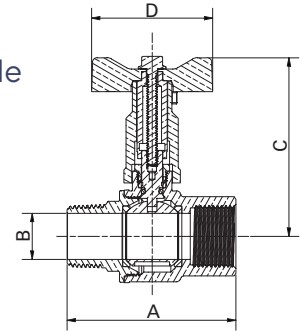
For 1/2" and 3/4" versions extension made of plastic sleeve PA6 loaded 50% glass fibre, for 1" version of nickel-plated CW617N UNI EN 12165



Attacchi Connections	Codice prodotto Product code		PN	A ±1mm	B mm	C mm	D mm	Conf. num. pezzi Pack. num. pieces
								
1/2"	382D1/2G6RFM	382D1/2G6BFM	60	63,5	15	73	52	40
3/4"	382E3/4G6RF	382E3/4G6BF	60	72,5	20	77	52	30
1"	382F001G6RF	382F001G6BF	40	86	25	88,5	65	30





NICHELATE NICKEL-PLATED

Per versioni 1/2" e 3/4" canotto prolunga in plastica PA6 caricata 50% fibra di vetro, per versioni da 1" a 1" in CW617N UNI EN 12165 nichelato

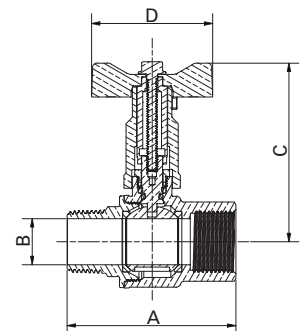
For 1/2" and 3/4" versions extension made of plastic sleeve PA6 loaded 50% glass fibre, for 1" version of nickel-plated CW617N UNI EN 12165



Attacchi Connections	Codice prodotto Product code		PN	A ±1mm	B mm	C mm	D mm	Conf. num. pezzi Pack. num. pieces
								
1/2"	382D1/2C6RFM	382D1/2C6BFM	60	63,5	15	73	52	40
3/4"	382E3/4C6RF	382E3/4C6BF	60	72,5	20	77	52	30
1"	382F001C6RF	382F001C6BF	40	86	25	88,5	65	30

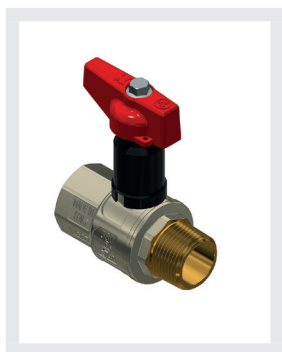



Con prolunga e manopola in alluminio
With extension stem and aluminium knob

NICHELATE ESTERNAMENTE
EXTERNALLY NICKEL-PLATED

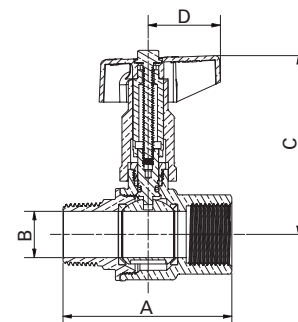
Per versioni 1/2" e 3/4" canotto prolunga in plastica PA6 caricata 50% fibra di vetro, per versioni da 1" a 1" 1/4 in CW617N UNI EN 12165 nichelato
 For 1/2" and 3/4" versions extension made of plastic sleeve PA6 loaded 50% glass fibre, for 1" to 1" 1/4 versions of nickel-plated CW617N UNI EN 12165





Attacchi Connections	Codice prodotto Product code		PN	A ±1mm	B mm	C mm	D mm	Conf. num. pezzi Pack. num. pieces
								
1/2"	382D1/2G2RFM	382D1/2G2BFM	60	63,5	15	73	31,5	40
3/4"	382E3/4G2RF	382E3/4G2BF	60	72,5	20	77	31,5	30
1"	382F001G2RF	382F001G2BF	40	86	25	91	42,5	30
1" 1/4"	382G11/4G2RF	382G11/4G2BF	40	101,5	32	105	50	20

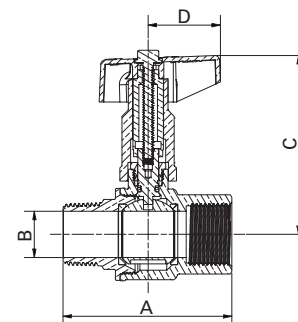

NICHELATE
NICKEL-PLATED

Per versioni 1/2" e 3/4" canotto prolunga in plastica PA6 caricata 50% fibra di vetro, per versioni da 1" a 1" 1/4 in CW617N UNI EN 12165 nichelato
 For 1/2" and 3/4" versions extension made of plastic sleeve PA6 loaded 50% glass fibre, for 1" to 1" 1/4 versions of nickel-plated CW617N UNI EN 12165



Attacchi Connections	prodotto Product code		PN	A ±1mm	B mm	C mm	D mm	Conf. num. pezzi Pack. num. pieces
								
1/2"	382D1/2C2RFM	382D1/2C2BFM	60	63,5	15	73	31,5	40
3/4"	382E3/4C2RF	382E3/4C2BF	60	72,5	20	77	31,5	30
1"	382F001C2RF	382F001C2BF	40	86	25	91	42,5	30
1" 1/4"	382G11/4C2RF	382G11/4C2BF	40	101,5	32	105	50	20